

SD3443/5443

Silicon Phototransistor

FEATURES

- TO-46 metal can package
- Choice of flat window or lensed package
- 90° or 18° (nominal) acceptance angle option
- Wide operating temperature range (-55°C to +125°C)
- External base connection for added control
- High sensitivity
- Mechanically and spectrally matched to SE3450/5450, SE3455/5455 and SE3470/5470 infrared emitting diodes

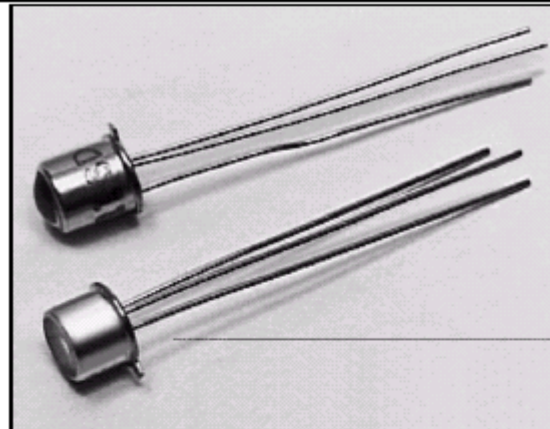

MPFA-57.11F

DESCRIPTION

The SD3443/5443 series consists of an NPN silicon phototransistor mounted in a TO-46 metal can package. The SD3443 has flat window cans providing a wide acceptance angle, while the SD5443 has glass lensed cans providing a narrow acceptance angle. The TO-46 packages are ideally suited for operation in hostile environments.

The base is connected on all SD3443 and SD5433 standard products.

OUTLINE DIMENSIONS in inches (mm)

Tolerance	3 plc decimals	±0.005(0.12)
	2 plc decimals	±0.020(0.51)

SD3443

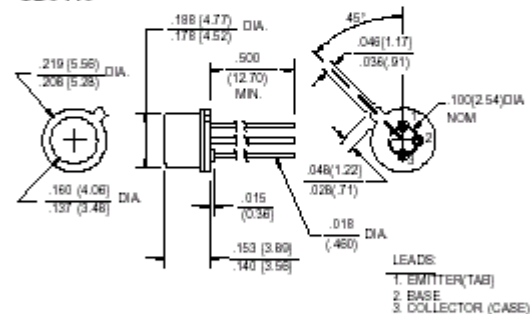

DM_015.454

SD5443

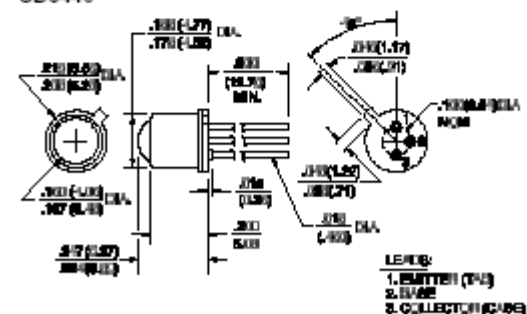

DM_150.454

SD3443/5443

Silicon Phototransistor

ELECTRICAL CHARACTERISTICS (25°C unless otherwise noted)

PARAMETER	SYMBOL	MIN	TYP	MAX	UNITS	TEST CONDITIONS
Light Current	L				mA	$V_{CE}=5\text{ V}$ $H=5\text{ mW/cm}^2$ (1)
SD3443-001		0.50				
SD3443-002		1.00				
SD3443-003		2.00				
SD5443-001		1.00				
SD5443-002		4.00				
SD5443-003		8.00				
SD5443-004		16.0				
Collector Dark Current	I_{CDO}			100	nA	$V_{CE}=10\text{ V}, H=0$
Collector-Emitter Breakdown Voltage	$V_{(BR)CEO}$	30			V	$I_C=100\text{ }\mu\text{A}$
Emitter-Collector Breakdown Voltage	$V_{(BR)ECO}$	5.0			V	$I_E=100\text{ }\mu\text{A}$
Collector-Emitter Saturation Voltage	$V_{CE(SAT)}$			0.4	V	$I_C=0.4\text{ mA}$ $H=5\text{ mW/cm}^2$ $I_E=\text{Constant}$
Angular Response (2)	θ				degr.	$I_E=\text{Constant}$
SD3443			90			
SD5443			18			
Rise And Fall Time	t_r, t_f		15		μs	$V_{CE}=5\text{ V}, I_C=1\text{ mA}$ $R_L=1000\text{ }\Omega$

Notes

- The radiation source is a tungsten lamp operating at a color temperature of 2870°K.
- Angular response is defined as the total included angle between the half sensitivity points.

ABSOLUTE MAXIMUM RATINGS

(25°C Free-Air Temperature unless otherwise noted)

Collector-Emitter Voltage	30 V
Emitter-Collector Voltage	5 V
Power Dissipation	150 mW (1)
Operating Temperature Range	-55°C to 125°C
Storage Temperature Range	-65°C to 150°C
Soldering Temperature (10 sec)	260°C

Notes

- Derate linearly from 25°C free-air temperature at the rate of 1.43 mW/°C.

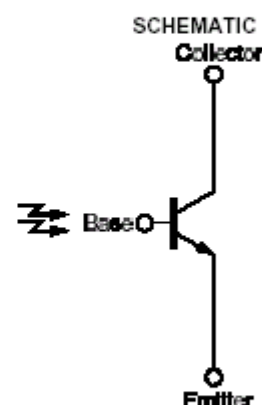

Honeywell reserves the right to make changes in order to improve design and supply the best products possible.

Honeywell

109

深圳市新世联科技有限公司

SD3443/5443

Silicon Phototransistor

SWITCHING TIME TEST CIRCUIT

dt_03.dat

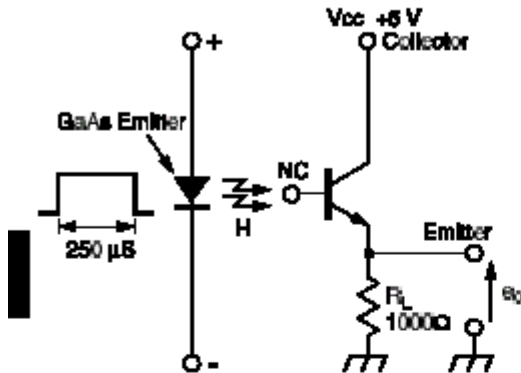

SWITCHING WAVEFORM

dt_004.dat

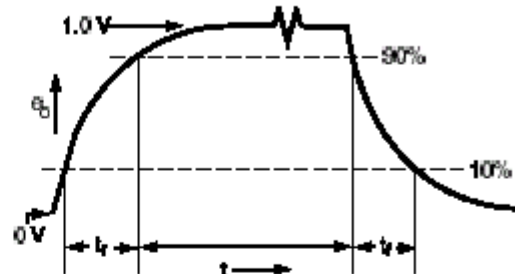

Fig. 1 Responsivity vs Angular Displacement (SD3443)

gra_052.ds4

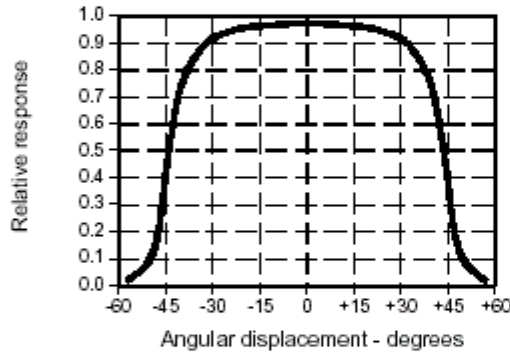

Fig. 2 Responsivity vs Angular Displacement (SD5443)

gra_053.ds4

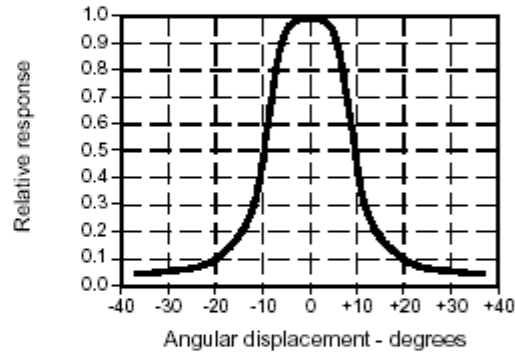

Fig. 3 Dark Current vs Temperature

gra_303.dat

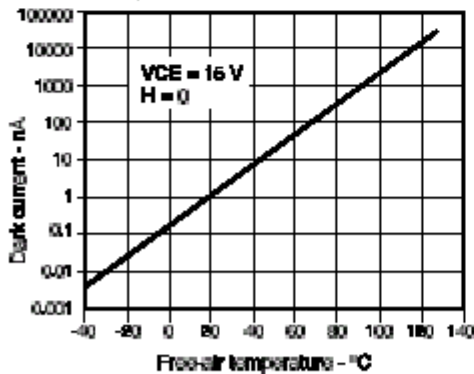
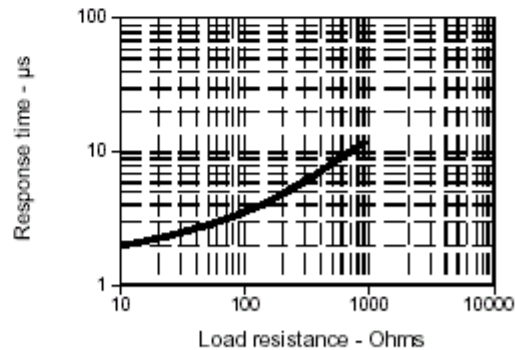

Fig. 4 Non-Saturated Switching Time vs Load Resistance

gra_041.ds4



SD3443/5443

Silicon Phototransistor

Fig. 5 Spectral Responsivity

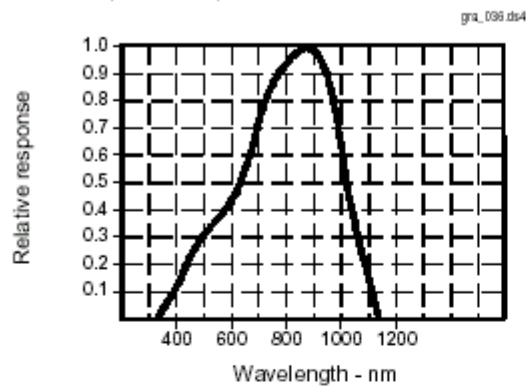

Fig. 6 Coupling Characteristics
SE3450 with SD3443

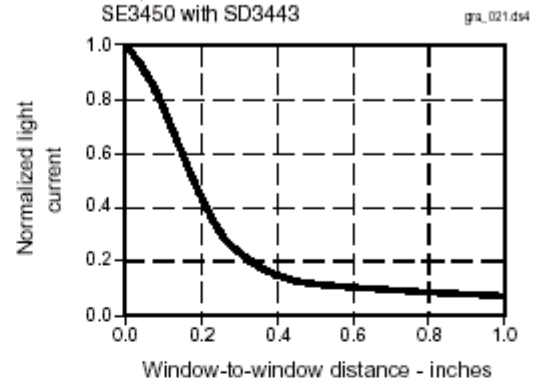

Fig. 7 Coupling Characteristics
SE5450 with SD5443

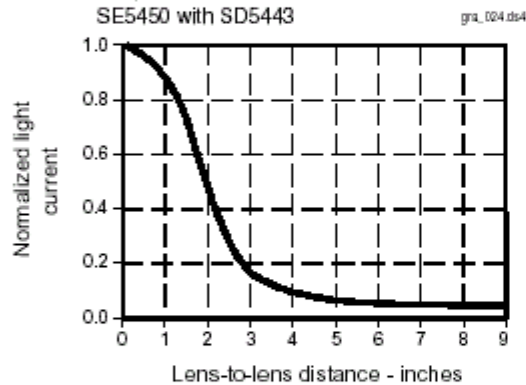
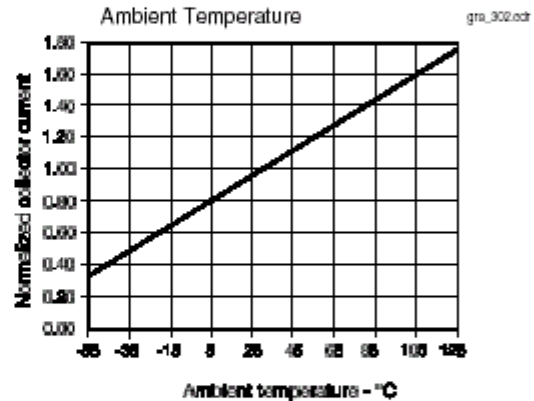

Fig. 8 Collector Current vs
Ambient Temperature



All Performance Curves Show Typical Values

Honeywell reserves the right to make changes in order to improve design and supply the best products possible.

Honeywell

111

深圳市新世联科技有限公司

地址: 深圳市深南中路2066号华能大厦712室
 电话: 0755-83680810 83680820 83680830 83680860
 网址: www.apollounion.com

邮编: 518031
 传真: 0755-83680866
 邮箱: sales@apollounion.com